



# Extreme environments

— case studies

EXTREME ENVIRONMENTS CASE STUDIES



# About Tykoflex



The Tykoflex factory in Tyresö, outside Stockholm, Sweden.

The choice of a high quality closure is essential to safeguard a good environment for optical fibres, especially when installed in harsh and demanding environments.

Once installed onto a pole, buried in the ground or mounted in a manhole or a handhole, the joint closure must do the job, decade after decade.

Tykoflex is the manufacturer of T240 closures. The company's closures have been used since 1977 for copper and since 1985 for fibre. More than 300,000 units have been installed all over the world.

Tykoflex AB is a family-owned Swedish company, founded in 1958 and based in Tyresö, south of Stockholm. The T240 outside plant closures are used by telecom and broadband operators, railway companies, mining and offshore industries, power companies and OEM equip-

ment suppliers in many countries. They are supplied as standard product items or adapted to customer configurations, and meet the highest requirements for harsh outdoor conditions, flexibility, technical performance and practical handling.

This T240 System overview is designed to simplify your choice of closure and accessories. For all enquiries and quotations, please contact us or your Tykoflex T240 distributor.

*We are there for you.*

*Tykoflex AB*

# Seaflex™ in Angola

***The Tykoflex Seaflex™ joint closure played a major part in the rollout of a new submarine fibre-optic cable network which connected Angola's coastal provinces.***

During 2007 Angola Telecom in collaboration with Ericsson Network Technologies installed a tailor-made, steel wire armoured fibre optic cable along Angola's entire coastline.

Ericsson supplied a total of 1,850 kilometres of fibre optic submarine cable to Angola Telecom, providing a backbone network for mobile traffic as well as broadband services. The new network aimed to improve both telephone and TV services in the six provinces Cabinda, Zaire, Luanda, Cuanza Sur, Benguela and Namibe.

The new network covers a majority of Angola's population. It complemented the earlier satellite backbone network and made reliable telecommunications services available to about 70 % of Angolans, most of whom live in cities, such as the capital Luanda, that are close to the sea. Angola Telecom operates the new system which is known as Adonis.

Installed with Seaflex™ submarine joint closure The Ericsson submarine cable, FIMT (fibre in metallic tube) can withstand depths of 2,000 metres. When Ericsson's factory in Hudiksvall provided its FIMT submarine cable, the project looked to Tykoflex for its expertise in fibre splicing products. The Seaflex™ submarine joint closure was delivered.

Seaflex™ is Tykoflex submarine joint closure for fibre optic submarine cables. The closure is made of highly corrosion-resistant, offshore quality stainless steel. Due to its modular cable adapter system it can be used with most cable designs and between cables from different manufacturers.

The cable ship Teliri, based in Catania, Sicily, was leased during the whole project. The Teliri is specially adapted for shipping and loading cable at sea and its first port of call for this project was Hudiksvall, Sweden, where the cable was loaded direct from the production line onto the ship.

\*Seaflex and Beachflex pending trademark application



Installation work in progress on the cable ship Teliri



# Tykoflex joint closures for wind turbines

***World leading wind turbine manufacturer Vestas chose Joint Closure T240 to get a universal solution that works for both offshore and onshore installations.***

The fibre-optic cable can be installed in conjunction with the foundation of the wind turbine being cast. It may take several months before the rest of the wind turbine is installed, meaning that the joint closure must withstand the harsh environment in the foundation of the wind turbine until its completion.

Vestas chose the Tykoflex T240 joint closure, as they wanted a reliable and sturdy box that could replace the earlier plastic closure. It had proven not to be an option to work with plastic boxes as they did not live up to the demands.

When building a wind turbine, it is common to cast the foundation months before the rest of the tower is in place. Fibre-optic cables are drawn from shore in conjunction with power cables and are installed with the Tykoflex T240 closure in the foundation of the wind turbine. The T240 closure handles both splicing, cross-con-

nection and interconnection of fibres. As it is common to build a large number of wind turbines in a wind power plant, the T240 also connects the wind turbines with each other.

When the tower is in place and all equipment needs to be installed, such as nacelle, blades and monitoring devices, the T240 joint closure provides a solid solution for splicing the cables.

The T240 joint closure has been specially adapted for this purpose in collaboration with manufacturers and has proved to be a great success. The SCADA software system monitors all the necessary data regarding wind speed, wind direction, mechanical control and the amount of power the wind turbines are producing. The use of fibre optic cable makes sure that a vast amount of information can be transmitted quickly and reliably.



# Tykoflex joint closures in the desert

*During 2006 Tykoflex delivered a large number of joint closures and pole brackets to the United Arab Emirates for the ADCO NEB Phase 1 Development Project.*

As the ADCO NEB Phase 1 Development Project progressed, a need for joint closures arose for the development of overhead circuits in the harsh environment of the desert. Tykoflex was the ultimate choice for meeting this need and the technical demands for the exposed positioning of the joint closures.

The extreme weather changes with high UV-radiation and sandblasting called for a joint closure that could withstand all of these conditions. Tykoflex has previously delivered joint closures to other projects in the region which have successfully withstood all of the weather conditions they have been exposed to.

Ranya Contracting Establishment is a part of ADCO's Abu Dhabi Company for Onshore Oil Operations development in the northeast of Abu Dhabi which includes the regions Dhabbiya and Rumaitha.

The total duration of this development was 18 months and during this time a total of 70 km, 33kV, 3-line overhead circuit on steel lattice towers with associated fibre optic cabling was developed in Dhabbiya.

In addition, 33kV, 3-line overhead circuit on wooden poles with 70km of fibre optic cabling was developed in Rumaitha. A total of 103 joint closures and pole brackets were delivered for this project from Tykoflex.

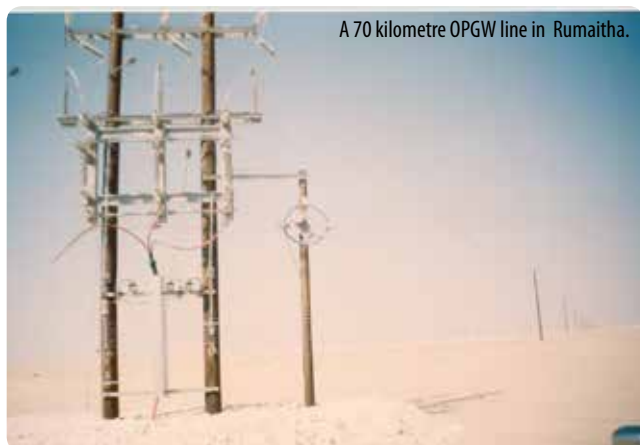

A 70 kilometre OPGW line in Rumaitha.

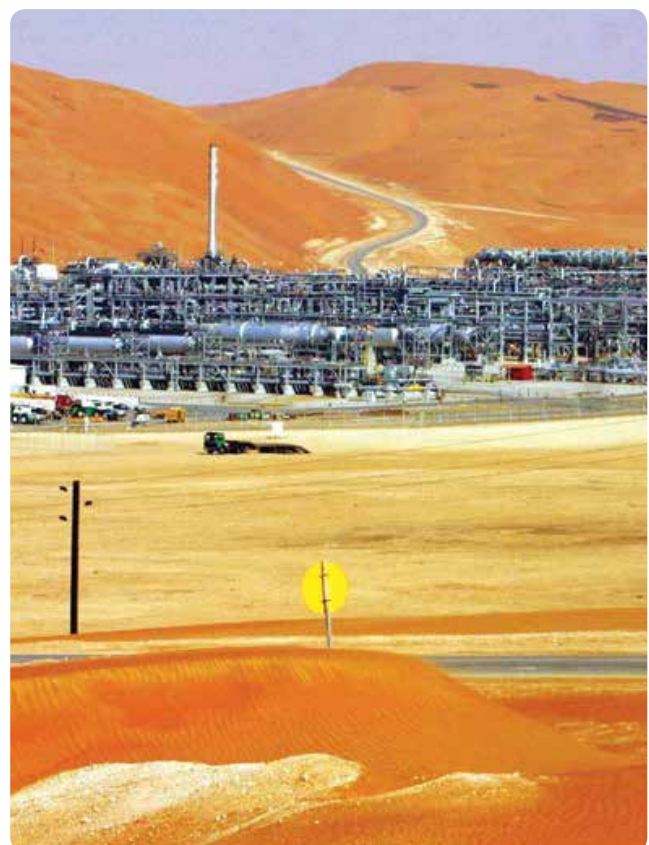

# NordBalt Project

*Tykoflex is a partner for the future supply of knowledge and products for infrastructure development in the Baltic sea area.*

ABB is the contractor producing the new HVDC Light transmission system between Sweden & Lithuania. The 700 MW  $\pm$ 300 kV transmission will link the electricity networks in the Baltic and Nordic regions.

It is the world's longest HVDC Light underground and subsea cable, and will help to strengthen the security of the power supply in the three Baltic countries and in southern Sweden, and integrate an emerging joint Baltic electricity market with the Nordic and European markets.

HVDC Light transmission will also increase capacity, facilitate power exchange, enhance grid reliability and improve the security of the electricity supply at either end.

ABB has designed, engineered, supplied and commissioned two 700 MW,  $\pm$ 300 kV (kilovolt) converter stations using ABB's HVDC Light technology, one in Nybro, Sweden, the other in Klaipeda, Lithuania. The project also includes the supply and installation of two

300 kV underwater cables, each 400 km long, and land cable routes comprising 40 km on the Swedish side, and 10 km on the Lithuanian side.

The communication link in the Nordbalt project is a 400km long Hexatronics Submarine fibre optic cable. The technology that is used to amplify the signal in the 400km cable is made using an advanced method called ROPA.

The technology is based onto a technique to amplify the light signal with passive components. This is made by that a special type of glass fibres are spliced into the cable in exact positions inside the Submarine Joint Closure 16-ROPA. ROPA Fibre unit is a product from the Canadian company MPB.

Submarine Joint Closure 16-ROPA is a product from the Tykoflex Seaflex™ family. The standard Seaflex™ closure for Hexatronic GJMLTV cable has been developed and certified for the 16 fibre ROPA unit. The Submarine Joint Closure 16-ROPA used in the project is designed for a 48 fibre cable and 16-ROPA fibres spliced inside each joint.

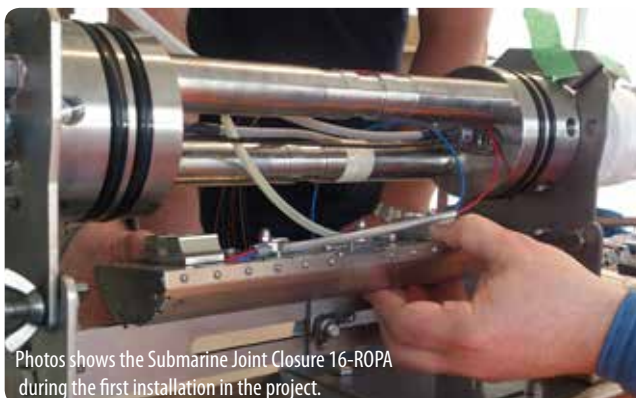
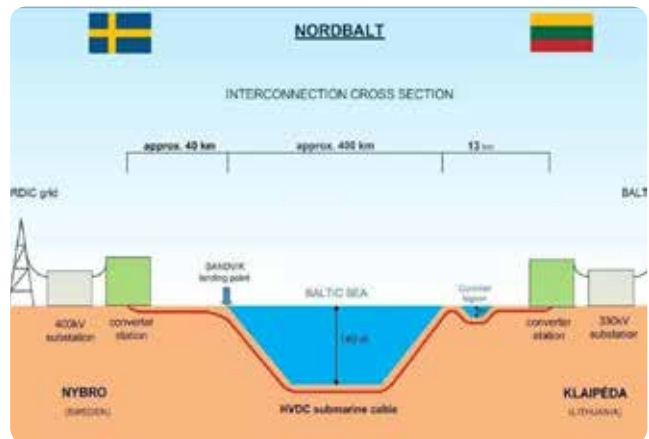

Photos shows the Submarine Joint Closure 16-ROPA during the first installation in the project.



# RL30 Obstruction Light

*The RL30 Obstruction Light safeguards high obstacles in the most demanding environments.*

The Halogen model keeps the lights absolutely ice free during cold and snowy conditions.

In dry and sunny regions it is often favourable to use the RL30 led model with very low, environmentally friendly, power consumption. This model can also be solar driven.

Through a unique construction with a stainless steel housing and a red, UV stabilized polycarbonate dome, together with the best available components, the burn life is 10 years or more.

The photo below of a high mast in very cold conditions shows an installation north of the Arctic Circle in Sweden.

If and when service is needed the hinged dome can be opened and the bulb changed, using only one hand.

## Benefits and key features for RL30:

- Low power consumption
- EMC approved
- Lifetime > 100,000 h
- Intensity >32 cd
- Color aviation red
- Horizontal plane 360°
- Vertical plane -10° +90°
- Easy installation
- Protection IP43
- Operating range -50° +55°C
- CE approved

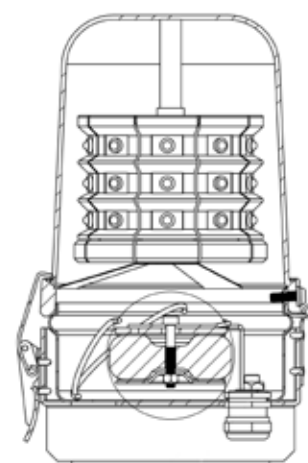

Few parts equals long life and trouble free operation.



Installations have been carried out in Greenland, Svalbard and Kiruna.



The easy access eccentric fastener, keeping the dome in position.

# Offshore

*Tykoflex closures have been in use since the late 1980s and have ensured safe network communication offshore.*

The Tykoflex joint closure has been in use on offshore oil platforms in all parts of the world for almost 40 years.

Our worldwide experience has given us great skills and knowledge to manufacture and adapt joint closures for all types of offshore installations.

The offshore industry sets very high standards for reliable installations that are easy to install and dependable under the most extreme conditions. Our team of experts and engineers help customers to choose the right type of joint closure for short lead times and cost effective solutions.

The T240 closure was also specified by the wind power industry and began to be used for offshore windmills during the 1990s.

# Beach manhole

*Joint Closure Beachflex™ is designed for harsh coastal environments.*

Joint Closure TA Beachflex™ is a complete system used for the transition between wire armoured submarine cable and/or land cable.

The photos below show a sea cable installation in a river crossing in Finland, near the village of Karis between Helsinki and Hangö.

The two Finnish operators Elisa and DNA share the same beach manhole for the T240 beach joints.

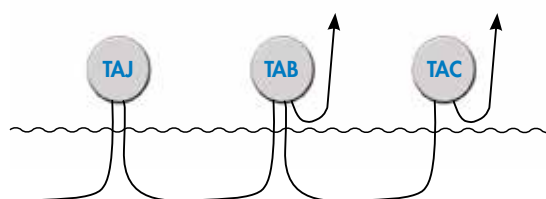

**TAJ= Joint TAB= Branch TAC= Connection**





# Martin Linge Project

**ABB produces the world's longest high voltage sub-sea AC cable for the Martin Linge oil & gas field in the North Sea. The cable will supply mainland power from the Norwegian grid.**

The field will receive its electricity feed through the world's longest subsea AC link – a 162 kilometre long high-voltage submarine power cable that will lie 370 metres below sea level, at its deepest point.

The 145 kilovolt, high-voltage 3-core polymeric XLPE insulated submarine cable will be capable of supplying up to 55 megawatts of AC power from the mainland grid to the new Martin Linge field. The cable will include fibre optic links to allow the facilities to be controlled from shore.

Tykoflex has supplied ABB with submarine joint closures for maintenance of the integrated fibre optic submarine cables in the Martin Linge project.

Closures for integrated cables include various models within the Seaflex™ family.

Tykoflex is a partner that supplies quality products for demanding projects, from design and manufacture to testing and delivery.

The photos below show the stiff repair joint for electrical power and optical cables. Three Tykoflex submarine joints for integrated optical cables are placed inside the stiff joint together with the joints for the electrical power cable.

The photos below were taken at an installation of a test cable during spring 2014. The aim of the installation was to test all components (cables and joints) for certification of all materials prior to delivery to the oil and gas field.

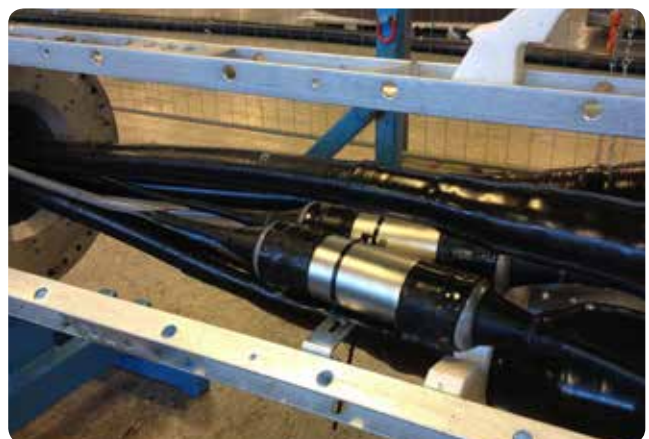
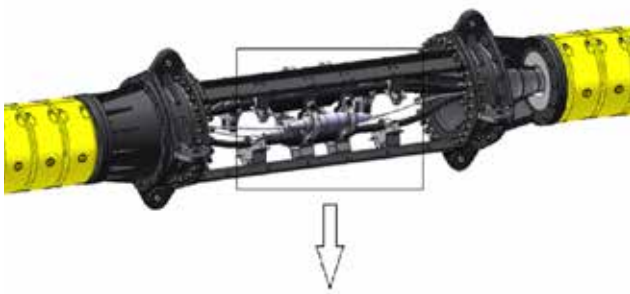

# Swedish Transport Administration

*TykoFlex has received a five year contract as the sole supplier for The Swedish Transport Administration (Trafikverket).*

The Swedish Transport Administration is the government agency responsible for long-term planning of the transport system. Trafikverket is also in charge of the maintenance of the national road and railway networks.

In Sweden today there are almost 100,000 kilometres of roads and 12,000 kilometres of railways. TykoFlex will supply joint closures for optical fibre as well as copper cable (ATC) signal systems.

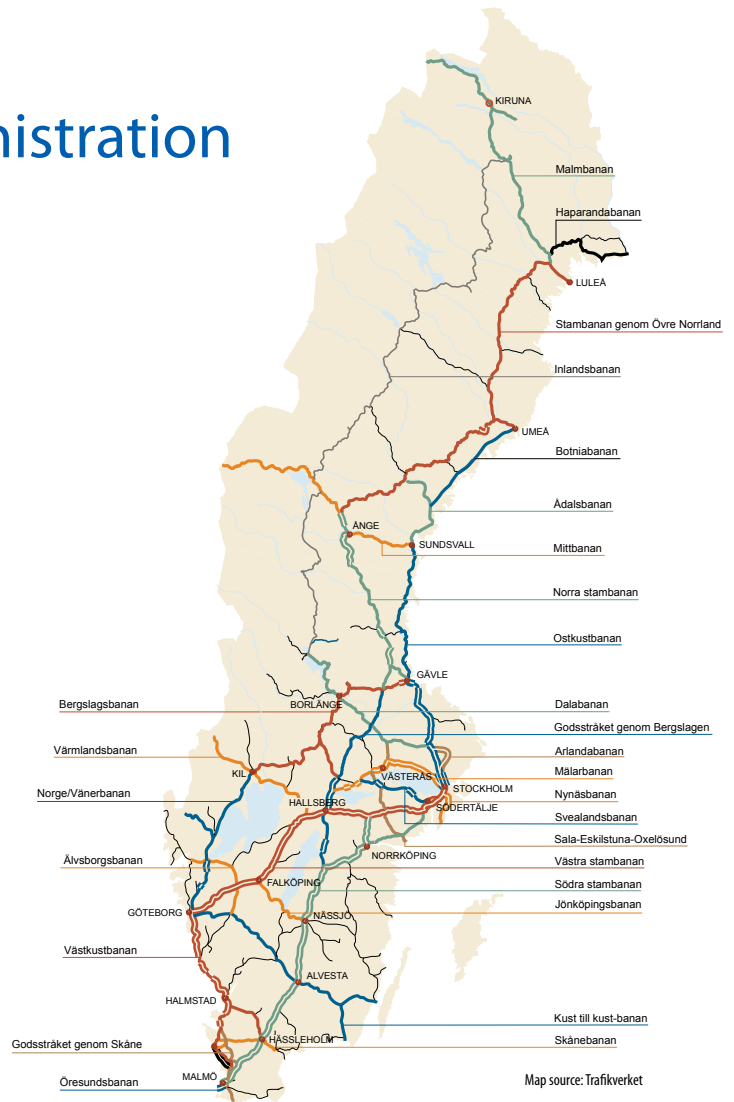

# Australia, OPGW in the field

*Tykoflex has delivered joint closures for LNG projects in Australia. The T240 OPGW Joint Closure is used for connection of wellheads in remote rural areas in North Queensland.*



- 420 km pipeline
- 193 well heads to be commissioned
- OPGW line to be strung



With Tykoflex joint closures and Mil Spec FRP (Fibre glass yarn) optical fibre cable assemblies utilising COTS ruggedised 12 channel connectors, a solution with the following advantages is achieved:

- *A reliable and ruggedised connection*
- *Fast installation of well head*
- *Easy connection of fibre (No splicing or termination required. Handling of connection can be carried out by non-specialist)*
- *Resistant to human, bovine or bird activity*



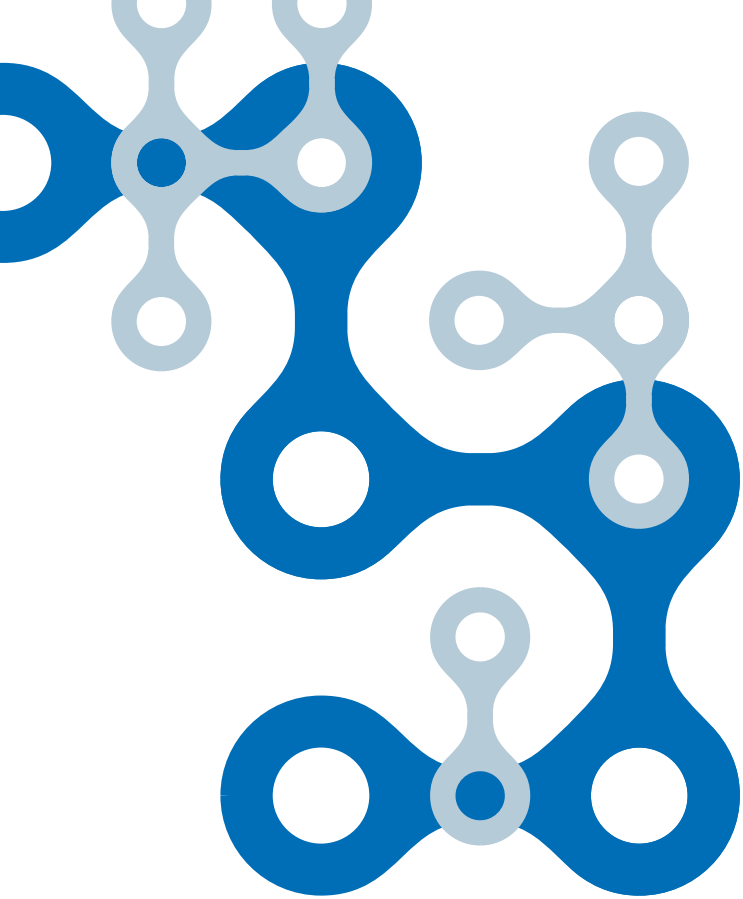

### **About Tykoflex**

*Tykoflex is an engineering company with our own product development, head office and manufacturing facility in Tyresö, just outside of Stockholm. Our main product ranges are enclosures for splicing optical fibre and fittings for pipe and hose systems. Besides a wide standard range of products, we can offer flexible production and customized solutions to suit all our customers' needs. For more information please visit [www.tykoflex.com](http://www.tykoflex.com)*

T240 fulfils international and European standards for outdoor closures.

IEC 61753-111-7

IEC 61753-111-8

IEC 61753-111-9

CENELEC EN 50411-2-2 (pan closures)

CENELEC EN 50411-2-4 (dome closures)



TYKOFLEX AB, P.O. Box 614, SE-135 26 Tyresö, Sweden  
Phone: +46 8 505 949 00, Fax +46 8 742 30 01  
[info@tykoflex.se](mailto:info@tykoflex.se) - [www.tykoflex.com](http://www.tykoflex.com)



TEN Group - 65 Wentworth Pl. Banyo QLD 4014  
Phone: +61 7 3212 9888  
[sale@tengroup.com.au](mailto:sale@tengroup.com.au) - [www.tengroup.com.au](http://www.tengroup.com.au)